

# Installation, Operation, and Maintenance Manual

## SentryPlus™ Alert

### Universal Upgrade Kit



**WARNING**



Read this Manual **BEFORE** using this equipment. Failure to read and follow all safety and use information can result in death, serious personal injury, property damage, or damage to the equipment. Keep this Manual for future reference.

**THINK SAFETY FIRST**

## SentryPlus Alert™

TECHNOLOGY

Powered by  syncta™

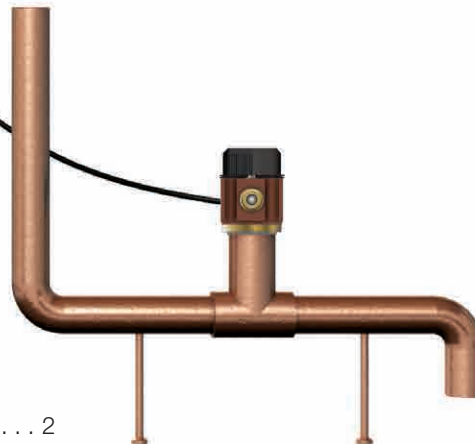

### Table of Contents

Important Safety Information . . . . .	2
Understanding Safety Information . . . . .	2
Description . . . . .	2
List of Parts . . . . .	2
Installation and Operation . . . . .	3
1. Installing the Flood Sensor (Backflow RPZ Upgrades) . . . . .	3
2. Installing and Wiring/Retrofitting the Control Box . . . . .	4-5
3. Installing the Cellular Gateway . . . . .	6
4. Setting Up the Cellular Gateway . . . . .	6
5. Registering SentryPlus Alert . . . . .	7
Start-up Instructions . . . . .	7
Overview . . . . .	8
Startup Sequence . . . . .	8
LEDs . . . . .	9
Buttons . . . . .	10
Terminals . . . . .	10
Troubleshooting Guide . . . . .	11-12
Warranty . . . . .	13

**NOTICE**

Use of the SentryPlus Alert™ technology does not replace the need to comply with all required instructions, codes, and regulations related to the installation, operation, and maintenance of an RPZ backflow preventor, including the need to provide proper drainage in the event of a discharge. Watts is not responsible for the failure of alerts due to connectivity or power issues.

## Important Safety Information

### ⚠ WARNING



To avoid death, serious personal injury, property damage, or damage to the equipment:

- Learn how to properly and safely use the equipment **BEFORE** installing, setting up, using, or servicing.
- Keep the manual available for easy access and future reference.
- Replace missing, damaged, or illegible manuals and product labels.
- Read the manual and all product labels and follow all safety and other information.
- Replacement manuals available at [Watts.com](http://Watts.com).

## Understanding Safety Information



This safety-alert symbol is shown alone or used with a signal word (DANGER, WARNING, or CAUTION). A pictorial and/or safety message to identify hazards and alert you to the potential for death or serious personal injury.

### ⚠ DANGER

Identifies hazards which, if not avoided, will result in death or serious injury.

### ⚠ WARNING

Identifies hazards which, if not avoided, could result in death or serious injury.

### ⚠ CAUTION

Identifies hazards which, if not avoided, could result in minor or moderate injury.

### NOTICE

Identifies practices, actions, or failure to act which could result in property damage or damage to the equipment.



This pictorial alerts you to the need to read the manual.



This pictorial alerts you to electricity, electrocution, and shock hazards.

## Description

- SentryPlus™ Alert Technology Universal Upgrade Kit detects catastrophic discharge from the relief valve of an RPZ (Reduced Pressure Zone) backflow preventer that can cause flooding due to excessive discharge and/or a blocked/undersized floor drain
- Wirelessly issues multi-channel alerts (call, text, email)
- Can be installed without taking equipment offline
- The SentryPlus Alert Technology Universal Upgrade Kit supports three types of applications:
  1. RPZ backflow preventer upgrades
  2. New LFF113RFP Flood Protection ACV (Automatic Control Valve) installations
  3. Existing LFF113RFP Flood Protection ACV upgrades to support SentryPlus Alert Technology

## List of Parts

The kit consists of following components:

- Control Box with a power adapter
- Cellular Gateway
- Flood Sensor
- 2" PVC Tee with NPTF threaded end connections to mount the Flood Sensor
- 6' 4-conductor electrical cable
- Mounting tabs, screws, and small flat head screwdriver



**SentryPlus Alert  
Technology Universal  
Upgrade Kit**

For existing LFF113RFP Flood Protection ACV upgrades, the system requires an additional component:

- Relay Box with mounting bracket (sold separately)

# Installation and Operation

## 1. Installing the Flood Sensor (Backflow RPZ Upgrades)

The Flood Sensor is installed in the discharge piping from the RPZ relief valve. If the Flood Sensor detects water in the discharge piping, it will signal the Control Box to close the valve.

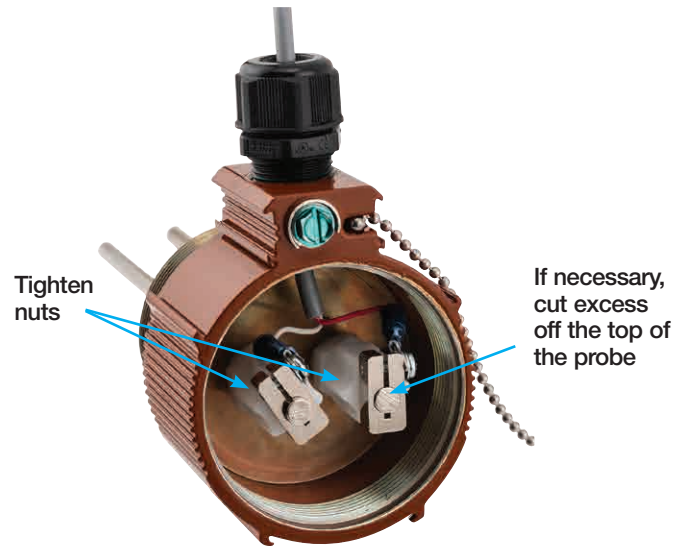
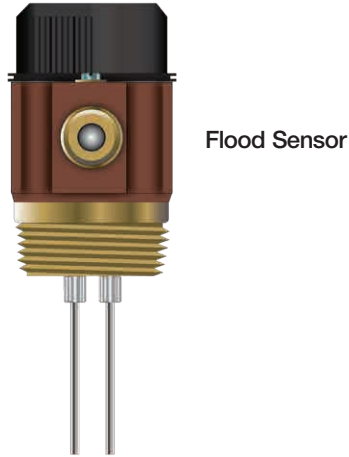

1. Identify a location to mount the Flood Sensor. It can be installed in either a 2" female NPT joint of your choice, or the 2" NPT tee included with the kit.
2. When using the supplied tee, install the sensor in the RPZ discharge line in the HORIZONTAL position. Install the Flood Sensor into the tee by screwing it in, ensuring that the probes point downward as shown below.

4. If the sensor probes are too long, cut off the top of probes so they fit properly when the cap is closed. To shorten the probe, loosen and lower the terminal block located at the top of the probe, then cut off the excess metal.
5. It's recommended that certified electrician should wire the sensor to the Control Box, as described in the next section.
6. Place the cap back on.

**NOTE:** Upon installation & Wiring, terminal blocks should not touch.

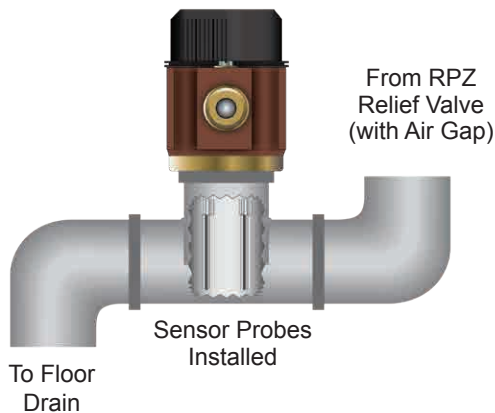

3. Unscrew the black cap to access the sensor probes. Push the two metal probes down until they touch the bottom of the pipe, then pull them up at least  $\frac{1}{4}$ ". The ends of the sensor probes should be located between  $\frac{1}{4}$ " and  $\frac{1}{2}$ " of the pipe's inner diameter from the pipe bottom. The probes **MUST NOT BE** less than  $\frac{1}{4}$ " from the pipe wall. Hand tighten the white plastic nuts on the probes to make it water tight.

### ⚠ CAUTION

Ensure Flood Sensor probes do not contact pipe bottom or sides.

# Installation and Operation

## 2. Installing and Wiring/Retrofitting the Control Box

### ⚠ WARNING

**Certified electrician to connect 110 VAC power and Control Box to Relay Box.**

### ⚠ CAUTION

**When retrofitting an existing Model 113RFP Flood Protection ACV, disconnect the electrical power before retrofitting the old Junction Box to the new one.**

### NOTICE

During the retrofitting process on the 113RFP, the system will not be monitoring for flood detection or protection..

### ⚠ WARNING



**Ensure that all power supply to the Control Box is turned off before making any connections to the Control Box. Failure to do so may result in electrocution, personal injury, and /or death.**

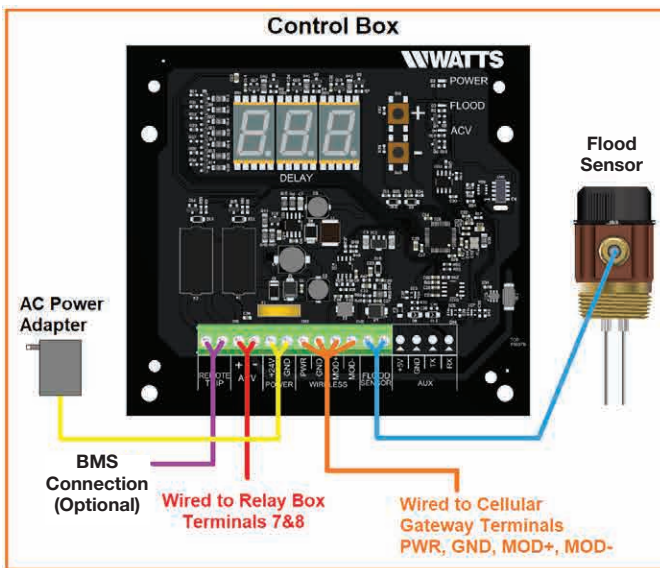

### NOTICE

- The terminal block accepts 14 to 24 AWG.
- Relay Box terminals have 24VDC/AC, 2A max.
- The Control Box uses an external 24VDC, 1.04A, 25W supply. This also powers the Cellular Gateway.
- The Sensor Probe is passive.

### For All Installations

The Control Box is designed to be mounted to a wall using the mounting tabs and screws provided with the kit, or it can be mounted on the ACV.

1. To open the Control Box, loosen the four screws located on the corners of its cover to access the internals of the Control Box.
2. Use a 300V, 14-24 AWG cable (not provided) to connect the Flood Sensor to the Control Box. Insert one end of the cable into wiring gland on the Control Box and attach two wires to the terminals labeled FLOOD SENSOR. There is no polarity.
3. Insert the other end of the cable into the opening on the Flood Sensor. Attach one wire to each terminal block located at the top of the probes. There is no polarity.
4. Optionally, use a cable to connect to a Building Management System or alarm for remote indications of a continuous water discharge at the terminals labeled REMOTE TRIP. There is no polarity.
5. Using the four-conductor communications cable with the kit, connect to the Cellular Gateway using the terminals labeled WIRELESS. Insert the cable through the wiring gland and attach one wire to each terminal. Cellular Gateway connections will be described in the next section, Installing the Cellular Gateway.

### Adjusting the Time Delay

The Flood Sensor has a delay feature which starts a timer once it detects water. The timer counts down before signaling that there's a discharge occurring. You can adjust the time delay to avoid having the valve close due to intermittent or nuisance relief valve discharge. The delay is adjustable from 0 to 120 seconds, and the default is 60 seconds.

Adjust the time delay by pressing the + or - button in the Control Box.

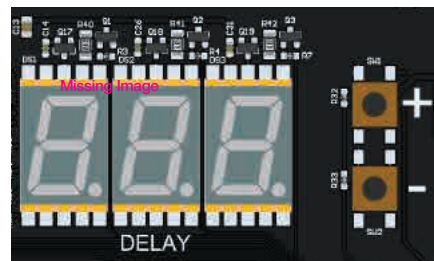

We recommend setting the delay between 3-60 seconds. However, the ideal set point can vary widely depending on the product application, including drain size, location, backflow preventer, water pressure, and tolerance for discharge. For example, if your backflow preventer releases water each time a booster pump turns on upstream and you know it will release water for 10 seconds before the system stabilizes, you can set the time delay to 15 seconds.

# Installation and Operation

## For New and Existing LFF113RFP ACV Installations

For convenience, new LFF113RFP ACVs are shipped with a Solenoid prewired to the Relay Box. Retrofitting an existing LFF113RFP requires an electrician to make that connection manually. New and existing ACV systems both require wiring to the Relay Box.

## For Existing LFF113RFP Installations Only

1. After removing power from the circuit, disengage the wiring from the main terminals inside existing Control Box:
  - Terminals 1 and 2 (Flood Sensor)
  - Terminals 3 and 4 (Solenoid)
  - Terminals 5 and 6 (Remote Trip Indicator, if wired)
2. Remove the Control Box from the ACV or wall mount.
3. Replace the existing control box and mounting bracket with the new Relay box and mounting bracket.
4. Using the cable from Solenoid, connect the Solenoid to the Relay Box. Attach the cable to the terminals 5 and 6 in the Relay Box. There is no polarity.
5. The Relay Box includes several spare terminals for your convenience to ease wiring requirements, such as building monitoring inputs or valve positioning.

## For New and Existing LFF113RFP Installations

1. Using an electrical cable (not provided), connect terminals 3 and 4 in the Relay Box to 110VAC power.
2. Using a 300 V, 14-24 AWG cable (not provided), connect the Relay Box to the Control Box. Attach one end of the cable to terminals 7 and 8 in the Relay Box. Attach the other end of the cable to the terminals labeled ACV in the Control Box. Connect Terminal 7 to ACV+. Connect Terminal 8 to ACV-.

## Solenoid Operation

The Solenoid is equipped with a Solenoid Bypass Valve (normally closed) which manually closes the Main Valve when engaged.

Opening the Solenoid Bypass Valve pressurizes the Main Valve cover as indicated by a pressure gauge, closing the Main Valve.

Closing the Solenoid Bypass Valve and opening the Manual Reset Ball Valve returns the Main Valve to the full open position.

The pressure gauge returns to zero when the Main Valve is fully open.

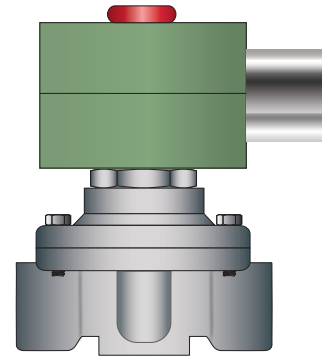

**NOTE:** Manual Reset Ball Valve must be closed for normal operation.

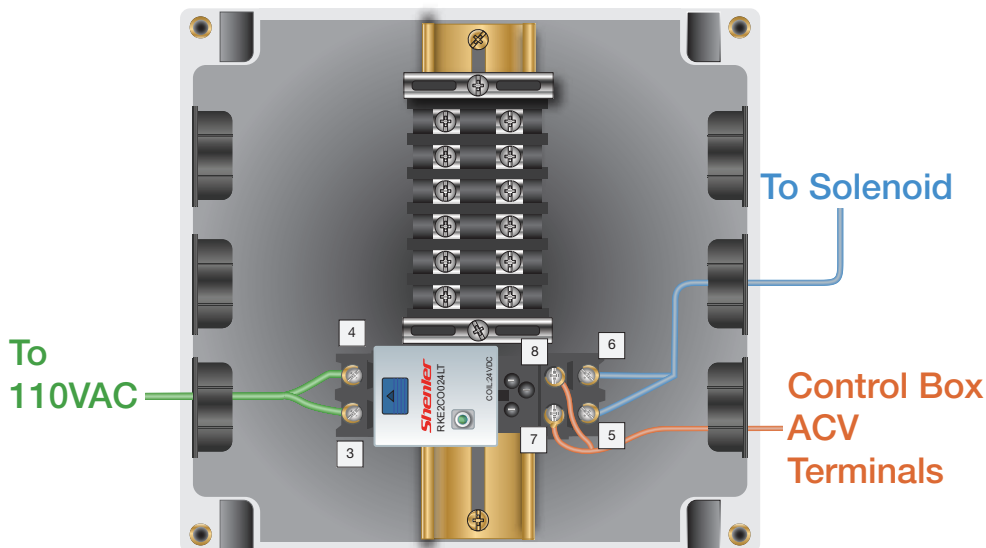

# Installation and Operation

## 3. Installing the Cellular Gateway

### ⚠ WARNING

Ensure all power supply to the Cellular Gateway is turned off before making any connections to the Cellular Gateway. Failure to do so may result in electrocution, personal injury, and/or death.

When identifying a location to mount the Cellular Gateway, the device must be placed away from large metal objects and structures that can block cellular signal. Additionally, the cellular antenna is located on the upper right inner side wall of the enclosure). When mounting, ensure that this of the device is away from any walls, wires, pipes, or other obstructions, especially anything metallic.

1. Before mounting, apply power to the Cellular Gateway to ensure there is adequate cell coverage. On startup, the CELL LED will blink at a rate of 1sec. This indicates it is searching for a cell connection. Once connected it turns steady blue. If connection is poor, it will blink with short OFF pulse every second. If there is a poor or no connection, find a new location.
2. Mount the Cellular Gateway at the selected location, using the mounting tabs and screws provided with the kit. Screws to attach the unit to the wall are not included.
3. Using the four-conductor cable supplied with the kit, connect the Control Box to the Cellular Gateway. Route wires from the WIRELESS terminals of the Control Box through the Cellular Gateway's wiring gland and connect to the matching terminals.

PWR to PWR

GND to GND

MOD+ to MOD+

MOD- to MOD-

Six feet of cable is supplied with the unit, but the Cellular Gateway can be located up to 100 feet away from the Control Box. If additional wire is used, it must meet the required rating for the Control Box (300V, 14-24 AWG).

4. To prevent water or dust from entering the cellular gateway, control box & relay box, tighten all wiring glands.
5. Apply power to the Control Box and Cellular Gateway.

## Cellular Gateway



Cellular  
Connection to  
Internet



Wired to Control Box

## 4. Setting Up the Cellular Gateway

1. **Start-Up** – Upon start-up, the POWER LED will light up a steady green to indicate power is supplied. The Cellular Gateway will automatically go into its start-up sequence. During the start-up sequence, the CELL and IoT LED will blink blue, indicating the Cellular Gateway is searching for a cellular connection. This may take up to 10 minutes. Once the cellular and Cloud connections are established, the CELL LED and IoT LED will be steady blue.
2. **Cellular Connection** – After the start-up sequence is completed, the CELL LED will be a steady blue if there is a good connection. It will blink with short OFF pulses if there is a poor connection.
3. **IoT Connection** – If there is a Cloud connection, the IoT LED will be a steady blue. IoT LED will blink if cloud connection is lost or not established. It will continue trying to connect indefinitely.

### NOTICE

If there is no Cloud connection, users will not receive notifications via Syncta.

4. **Flood LED** – If a flood event occurs, the FLOOD LED will be a steady orange. It will remain on as long as there is a flood condition.
5. **Test Button** – When cellular and Cloud connections have been made, you can send a test message through the Syncta app by pressing the TEST button.
6. **Reset Button** – You can reset the Cellular Gateway and restart the start-up sequence by pressing the RESET button. This will cause all on-going operations to cease.

# Installation and Operation

## 5. Registering SentryPlus Alert

- Using a smart phone or tablet, scan the QR code on the side on the Cellular Gateway, or go to <https://connected.syncta.com>

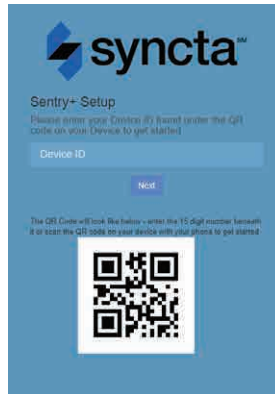

- When prompted, enter the Device ID. The Device ID is the set of numbers printed beside the QR code on the side of the Cellular Gateway.

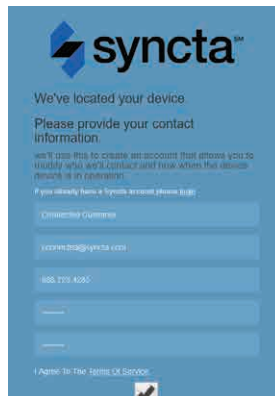

- Follow the prompts to create a Syncta account, or if you are an existing Syncta user, log in to your account. The device can be registered to multiple accounts.

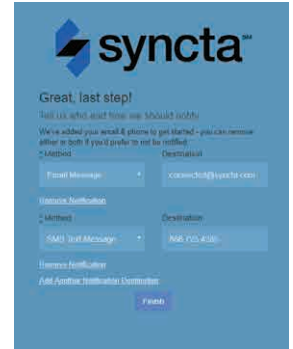

- Once the device is registered to your account, follow prompts to add notifications.



To manage alerts, login to your account on Syncta.com.

## Start-up Instructions

- Open the Control Box. Apply power.
- Pour an adequate amount of water into the RPZ Relief Valve Air Gap until the DELAY counter begins to count down. This indicates the Flood Sensor is properly installed and is sensing water in the discharge piping.
- Trap water in the discharge piping. The Solenoid will energize when the duration of time delay elapses. The FLOOD LED will be solid orange. The valve will close and must be manually reset. Adjust the Time Delay to the customer/project specifications.
- As a final test, simulate an actual RPZ Relief Valve discharge and observe the floor drain for excessive pooling or flooding. Re-adjust the time delay and Adjustable Closing Speed Control as needed to achieve the desired valve closure time.

### Valve Travel

VALVE SIZE - INCHES	1¼	1½	2	2½	3	4	6	8	10
Travel - Inches	¾	¾	¾	5/8	¾	1	1½	2	2½

### Valve Cover Chamber Capacity

VALVE SIZE - INCHES	1¼	1½	2	2½	3	4	6	8	10
fl. oz.	4	4	4	10	10	22	70		
U.S. Gal								1¼	2½

# Overview

## WARNING



**THINK  
SAFETY  
FIRST**

Read this Manual **BEFORE** using this equipment. Failure to read and follow all safety and use information can result in death, serious personal injury, property damage, or damage to the equipment. Visit [Watts.com](http://Watts.com) with any questions. Keep this Manual for future reference.

This User Guide provides information about the different LED lights, buttons, and connectors inside the SentryPlus Alert Cellular Gateway, as well as troubleshooting suggestions if needed.

For more information about the Cellular Gateway, see the Installation, Operation, and Maintenance Manual.

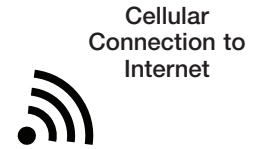

## Cellular Gateway



Wired to Control Box

## Startup Sequence

When the Cellular Gateway powers up, the device goes through a startup sequence. Below is the startup sequence that the device will go through if everything is working correctly.

COLOR	STATE	DEFINITION
	Steady Green	Green LED turns on - when power is applied
	Cell LED blinks	Trying to establish a cellular connection.
	IoT LED blinks	Trying to establish a connection to the Watts Cloud.



# LEDs

The LEDs inside the Cellular Gateway indicate if a component/ connection is running, or if there is an issue. The following sections describe the different LED colors and blink patterns.

## Power

The POWER LED turns on when power is supplied to the device.

COLOR	STATE	DEFINITION	SOLUTION
	Steady Green	The device is turned on.	N/A
	Off	If the device is plugged in, but this LED is not on, the device is not receiving power.	Check wiring to control box.

## Cellular

The CELLULAR LED indicates whether or not a cellular connection is present.

COLOR	STATE	DEFINITION	SOLUTION
	Steady Blue	A cellular connection is present.	N/A
	Short off blink	The cellular connection is poor.	See Poor or No Cellular Reception on page 11.
	Blue blinking	There is no cellular connection — searching.	See Poor or No Cellular Reception on page 11.

## IoT

The IoT LED indicates whether or not there is a connection to the Cloud.

COLOR	STATE	DEFINITION	SOLUTION
	Steady Blue	There is a connection to the Watts Cloud.	N/A
	Blinking	There is <b>not</b> a connection to the Watts Cloud. Trying to establish connection.	See No Connection to the Cloud on page 12.

## Flood

The FLOOD LED only turns on when excessive relief valve discharge from your backflow assembly is detected.

COLOR	STATE	DEFINITION	SOLUTION
	Steady Orange	Water is discharging from the relief valve of your backflow assembly, and it is more than a slight drip.  <b>Note:</b> This will only turn on if water discharge is detected and delay timer has reached 0.	If your device is registered, you will receive a “flood notification” via text, email and/or a phone call.
	Blinking	There is a problem with the Modbus connection between the Control Box and Cellular Gateway.	Check the wiring between the Control Box and Cellular Gateway on page 10.
	Off	There is no discharge occurring.	N/A

# Buttons

The only buttons that you might need to use are the RESET and TEST buttons. See the section below for more information. Both can be used by user.



## RESET

Press this to reset the Cellular Gateway and restart the device. This will cause all ongoing operations to cease.

**Note:** You can also perform a full reset by removing power to the Cellular Gateway for 10 seconds and then plugging it back in.



## TEST

Press to have a test notification sent.

**Note:** The unit must have already been registered and communication preferences set for these notifications to be sent.

## Cellular Gateway

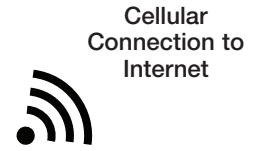

Wired to Control Box

# Terminals

Terminals wire to Control Box (PWR, GND, MOD+, MOD-). Terminals labeled INPUT 1 & INPUT 2 are reserved for future use.

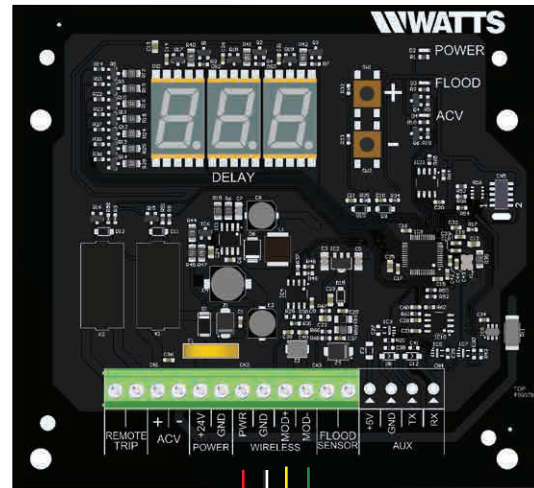
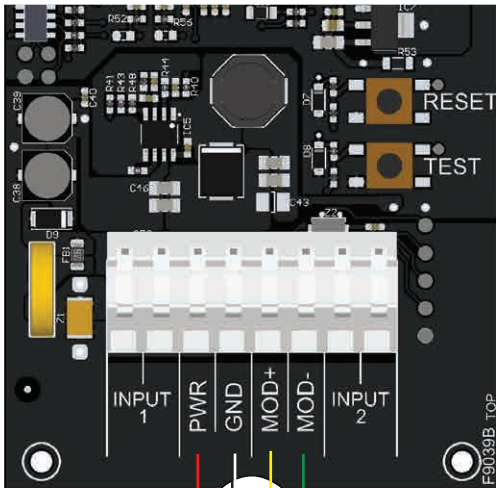

Power Outlet  
Ground  
MOD+  
MOD-

# Troubleshooting Guide

This section provides troubleshooting solutions to the most common issues if your Cellular Gateway is not working correctly. If you are unable to resolve your issue, contact your local Watts representative to order a replacement device.

## Poor or No Cellular Reception

Poor or no cellular reception will cause notifications to not work. As noted in the Installation, Operation and Maintenance Manual, the installation location is important for cellular reception. If the CELLULAR LED is blinking due to poor or no connection, the most likely issue is poor reception. If the device is still not working, review the possible causes and solutions below.

### Possible Cause 1

The location where the antenna is installed may be interfering with cellular reception.

**Note:** Care should be taken to ensure that the antenna side of the device is installed away from any walls, wires, pipes, or other obstructions, particularly anything metallic.

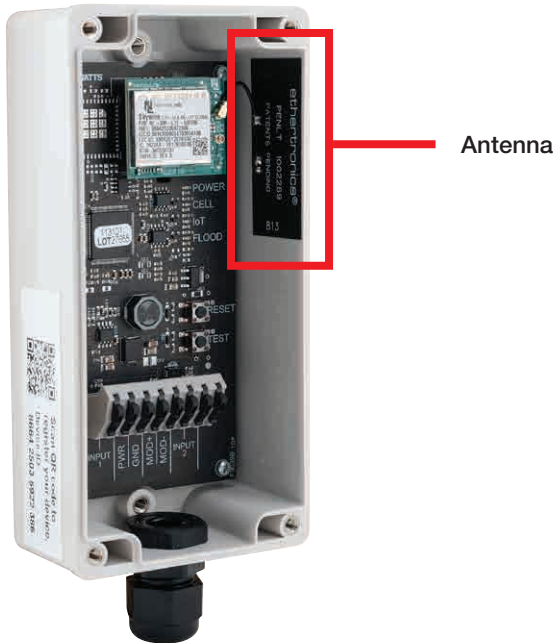

### Solution 1

Move the Cellular Gateway to a location where the antenna is not facing any internal walls, wires, pipes, or other obstructions, such as an electrical box.

### Possible Cause 2

The location has poor cellular reception.

### Solution 2

Move your Cellular Gateway to a different location and check to see that the CELLULAR LED is steady blue; if it is not, move the device until you find a location with better cellular reception.

**Note:** You can install the Cellular Gateway up to 100 feet away from the Junction Box. Six feet of wire is supplied with the Cellular Gateway. If additional wire is used, it must meet the required rating for the Junction Box (300V, 14-24 AWG).

Please consider the following before installing the Cellular Gateway outdoors:

- If the unit is installed outdoors, additional precautions may need to be taken to ensure the wire entry at the bottom of the node is adequately sealed (with silicone or something similar) to prevent water intrusion.
- Do not install in direct sunlight.
- Depending on the geographical location, condensation buildup inside the enclosure is a concern.

# Troubleshooting Guide

## Possible Cause 3

Cellular reception might not be supported at your site.

The Cellular Gateway operates using AT&T LTE Cat-M1. **Mobile phone reception is not a reliable indicator of expected signal strength for the Cellular Gateway.**

## Solution 3

If you cannot find cellular reception anywhere at your site, you may not have carrier coverage at your site. Contact Syncta's Customer Support team at 888-725-4285 for more information.

## POWER LED is Off

If the POWER LED is off, make sure the Cellular Gateway is plugged in and that the power outlet is active, wired to Control Box correctly and control box is powered with the provided 24Vdc power supply. If the device is still not working, review the possible cause and solution below.

## Possible Cause

If the Cellular Gateway is plugged in and the POWER LED is off, the +24Vdc & GND wiring polarity inside the Cellular Gateway might have been accidentally swapped.



## Solution

Use the instructions below to swap the +24Vdc and GND wiring inside the Cellular Gateway.

1. Remove power from the control box.
2. Swap places of the wires in the power terminals of the Cellular Gateway.
3. Reapply power to the control box
4. If the POWER LED is still off, contact Syncta's Customer Support team (support@syncta.com or 888-725-4285).

## No Connection to the Cloud

If the IoT LED is blinking, there is no connection to the Watts Cloud. If the device is not working, review the possible cause and solution below.

## Possible Cause

There is a disruption in service between the Watts Cloud and the Cellular Gateway.

## Solution

Contact Syncta's Customer Support team (support@syncta.com or 888-725-4285) to confirm if the issue is specific to your Cellular Gateway or to the cellular service provider.







**Limited Warranty:** Watts (the "Company") warrants each product to be free from defects in material and workmanship under normal usage for a period of one year from the date of original shipment. In the event of such defects within the warranty period, the Company will, at its option, replace or recondition the product without charge.

**THE WARRANTY SET FORTH HEREIN IS GIVEN EXPRESSLY AND IS THE ONLY WARRANTY GIVEN BY THE COMPANY WITH RESPECT TO THE PRODUCT. THE COMPANY MAKES NO OTHER WARRANTIES, EXPRESS OR IMPLIED. THE COMPANY HEREBY SPECIFICALLY DISCLAIMS ALL OTHER WARRANTIES, EXPRESS OR IMPLIED, INCLUDING BUT NOT LIMITED TO THE IMPLIED WARRANTIES OF MERCHANTABILITY AND FITNESS FOR A PARTICULAR PURPOSE.**

The remedy described in the first paragraph of this warranty shall constitute the sole and exclusive remedy for breach of warranty, and the Company shall not be responsible for any incidental, special or consequential damages, including without limitation, lost profits or the cost of repairing or replacing other property which is damaged if this product does not work properly, other costs resulting from labor charges, delays, vandalism, negligence, fouling caused by foreign material, damage from adverse water conditions, chemical, or any other circumstances over which the Company has no control. This warranty shall be invalidated by any abuse, misuse, misapplication, improper installation or improper maintenance or alteration of the product.

Some States do not allow limitations on how long an implied warranty lasts, and some States do not allow the exclusion or limitation of incidental or consequential damages. Therefore the above limitations may not apply to you. This Limited Warranty gives you specific legal rights, and you may have other rights that vary from State to State. You should consult applicable state laws to determine your rights. **SO FAR AS IS CONSISTENT WITH APPLICABLE STATE LAW, ANY IMPLIED WARRANTIES THAT MAY NOT BE DISCLAIMED, INCLUDING THE IMPLIED WARRANTIES OF MERCHANTABILITY AND FITNESS FOR A PARTICULAR PURPOSE, ARE LIMITED IN DURATION TO ONE YEAR FROM THE DATE OF ORIGINAL SHIPMENT.**



**USA:** T: (978) 689-6066 • F: (978) 975-8350 • Watts.com

**Canada:** T: (905) 332-4090 • F: (905) 332-7068 • Watts.ca

**Latin America:** T: (52) 81-1001-8600 • Watts.com