

**CODE NUMBER**

10021302

**DESCRIPTION**

SU-1009 Urinal and ROYAL 186 SMOOTH Flushometer.

**COMPONENTS**

- Flushometer: Code 3912712
- Urinal: Code 1101009

**DETAILS**

- Flush Volume: 0.25 gpf (0.9 Lpf)
- Nominal Dimensions: 14 ¼" x 17 ¼" x 25 ½" (362 x 438 x 648mm)

**FLUSHOMETER FEATURES**

- Non-Hold-Open Handle, Fixed Metering Bypass and No External Volume Adjustment to Ensure Water Conservation
- Vacuum Breaker with Flush Connection
- Sweat Solder Adapter with Cover Tube and Cast Wall Flange
- 3/4" I.P.S. Screwdriver Bak-Chek™ Angle Stop
- Diaphragm, Handle Packing and Vacuum Breaker Molded from PERMEX® Rubber Compound for Chloramine Resistance
- High Chloramine Resistant PERMEX® Synthetic Rubber Diaphragm with Linear Filtered Bypass and Vortex Cleansing Action™

Optima SMOOTH Unit

- "User in View" Flashing LED
- ADA Compliant OPTIMA® SMOOTH® Line Powered Infrared Sensor for automatic "Hands-free" operation
- Sensor with Automatic Range Adjustment
- Mechanical Manual Override Flush Handle

**FIXTURE FEATURES**

- White Vitreous China
- Washdown flushing action
- Integral flushing rim
- ¾" I.P.S. top spud inlet
- 2" NPT outlet flange
- Vandal resistant strainer assembly included
- All mounting hardware included
- 100% factory flush tested



**COMPLIANCES & CERTIFICATIONS**



(ADA Compliant, cUPC Green Certified, WaterSense Listed, BAA Compliant, Satisfies LEED Credits)

**DOWNLOADS**

- [Standard Spud Urinal Installation Instructions](#)
- [SS/ST/SU/WETS/WEUS Fixtures Repair and Maintenance Guide](#)
- [Additional Downloads](#)

**NOTES**

All information contained within this document subject to change without notice.

**ROUGH-IN**

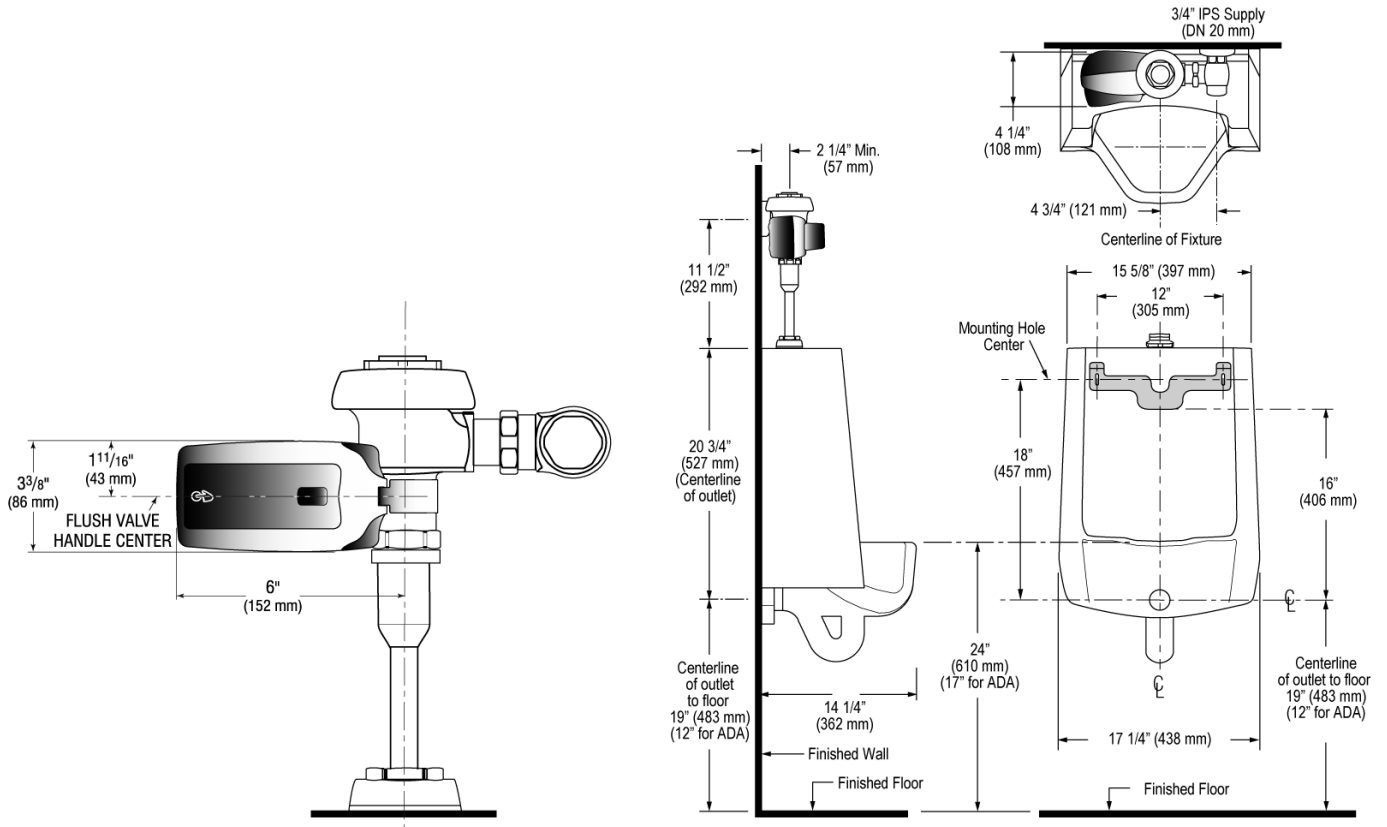

Sloan 10500 Seymour Ave, Franklin Park, IL 60131

Phone: 800.982.5839 • Fax: 800.447.8329 • [sloan.com](http://sloan.com)