

Class 300 Bronze Gate Valves

Block Pattern • Union Bonnet • Non-Rising Stem • Alloy Solid Wedge

300 PSI/20.7 bar saturated steam to 421° F/216° C
600 PSI/41.4 bar non-shock cold working pressure

CONFORMS TO MSS SP-80

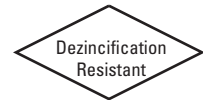

T-176-SS
T-176-A
Threaded

MATERIAL LIST	
PART	SPECIFICATION
1. Handwheel Nut	300 Series Stainless Steel
2. Identification Plate	Aluminum
3. Handwheel	Malleable Iron ASTM A 47
4. Stem	Silicon Bronze ASTM B 371 Alloy C69400/C69430 or ASTM B 99 Alloy C65100
5. Packing Nut	Bronze ASTM B 62 or ASTM B124 Alloy C37700 or Alloy C36000
6. Packing Gland	Bronze ASTM B 62 or ASTM B124 Brass ASTM B16 C36000
7. Packing	Aramid Fibers with Graphite
8. Stuffing Box	Bronze ASTM B 61
9. Bonnet	Bronze ASTM B 61
10. Union Nut	Bronze ASTM B 61
11. Body	Bronze ASTM B 61
12. Wedge	T-176-SS Bronze ASTM B 61 T-176-A Copper Nickel Alloy
13. Seats	T-176-SS Stainless Steel Type 410 ASTM A 276 Alloy 541000 T-176-A Integral with Body

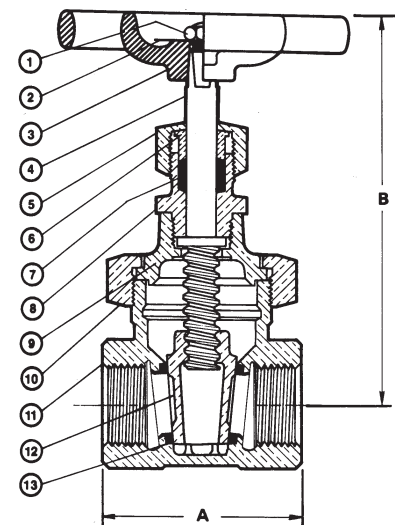

T-176-SS
NPT x NPT
with Stainless Steel Seats

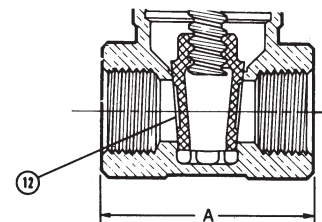

T-176-A
NPT x NPT
with Integral Seats

DIMENSIONS—WEIGHTS—QUANTITIES

Size	Dimensions								T-176-SS		T-176-A		Master Ctn.	Qty.
	A		B		A		B							
	In.	mm.	In.	mm.	In.	mm.	In.	mm.	Lbs.	Kg.	Lbs.	Kg.		
1/4	8	x	x	x	x	1.88	48	3.88	98	x	x	1.15	0.52	50
3/8	10	x	x	x	x	2.06	53	3.88	98	x	x	1.14	0.52	50
1/2	15	2.38	60	4.19	106	2.31	59	4.31	106	1.44	0.65	1.44	0.65	40
3/4	20	2.69	68	4.63	117	2.44	62	4.63	117	2.15	0.98	2.13	0.97	30
1	25	3.13	79	5.44	138	2.88	73	5.44	138	3.25	1.47	3.24	1.47	20
1 1/4	32	3.44	87	6.06	154	3.13	79	6.06	154	4.56	2.07	4.57	2.07	10
1 1/2	40	3.75	95	7.13	181	3.38	86	7.13	181	6.02	2.73	5.98	2.71	10
2	50	4.25	108	8.31	211	3.88	99	8.31	211	10.46	4.74	10.18	4.62	6

x Not available this size.

FREEZING WEATHER PRECAUTION: Subsequent to testing a piping system, valves should be left in an open position to allow complete drainage.

◆ For detailed Operating Pressure, refer to Pressure Temperature Chart on page 114.

WARNING: This product can expose you to chemicals including lead, which is known to the State of California to cause cancer and birth defects or other reproductive harm. For more information go to www.P65Warnings.ca.gov.

Visit our website for the most current information.