

### Features

- Low-threshold design for easy entry and exit.
- Covered drain with removable cover.
- Single threshold for alcove installation.
- Durable acrylic construction.
- Center drain.
- Coordinates with other products in the Archer collection.

### Recommended Products/Accessories

K-9132 Shower Drain  
K-702011-L Frameless Pivot Shower Door  
K-702408-G54 Frameless Pivot Shower Door  
K-702408-L Frameless Pivot Shower Door  
K-705701-L Frameless Pivot Shower Door  
K-705707-L Frameless Pivot Shower Door  
K-705713-L Frameless Pivot Shower Door  
K-705719-L Frameless Pivot Shower Door  
K-705725-L Frameless Pivot Shower Door  
K-705737-L Frameless Pivot Shower Door  
K-705802-L Semi-Frameless Pivot Shower Door  
K-705803-L Semi-Frameless Pivot Shower Door  
K-705816-L Semi-Frameless Pivot Shower Door  
K-705817-L Semi-Frameless Pivot Shower Door



### Codes/Standards











ASME A112.19.1/CSA B45.2  
CSA B45.5/IAPMO Z124  
ASTM E162  
ASTM E662

### KOHLER® Plastic Baths and Receptors Lifetime Limited Warranty

See website for detailed warranty information.

### Available Colors/Finishes

*Color tiles intended for reference only.*

| Color  | Code | Description   |
|--|------|---------------|
|  | 0    | White         |
|  | 96   | Biscuit       |
|  | 47   | Almond        |
|  | NY   | Dune          |
|  | 95   | Ice™ Grey     |
|  | G9   | Sandbar       |
|  | 33   | Mexican Sand™ |
|  | K4   | Cashmere      |
|  | 58   | Thunder™ Grey |
|  | 7    | Black Black™  |

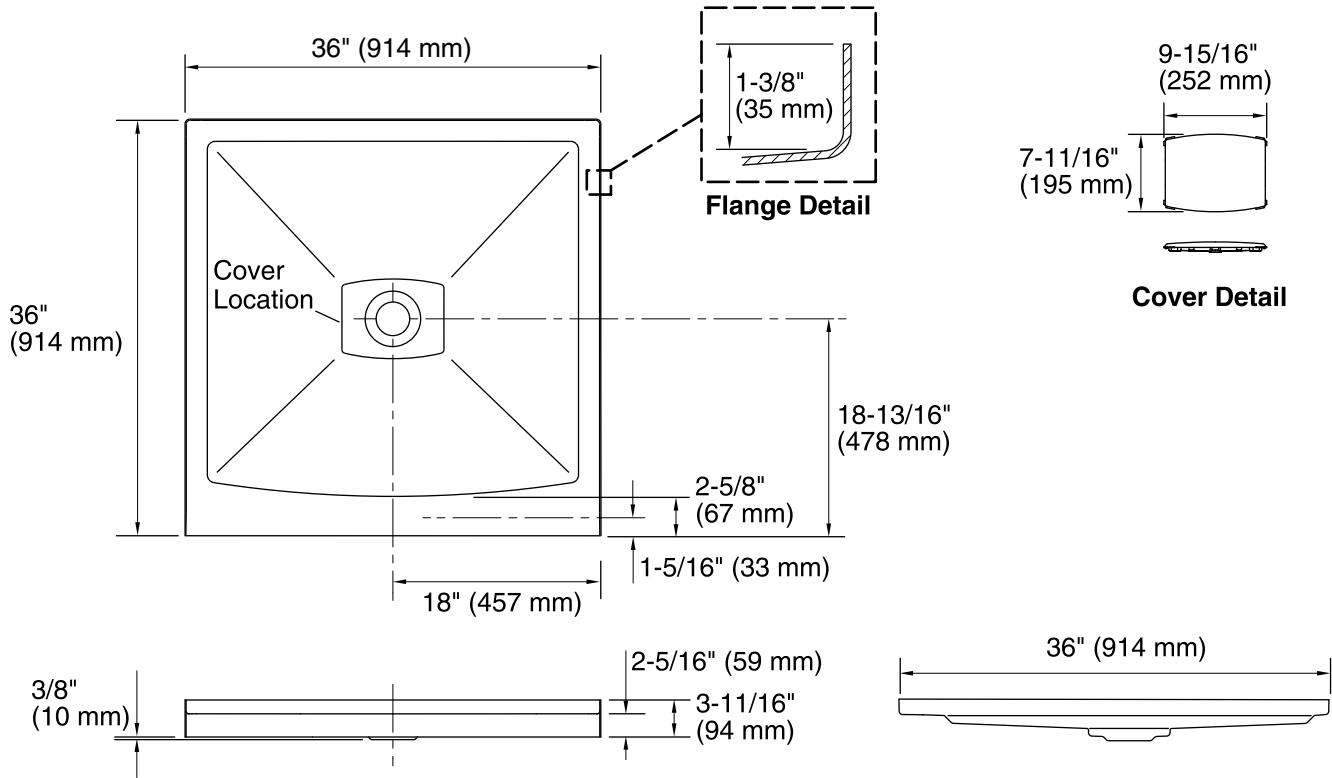

## Technical Information

All product dimensions are nominal.

|                     |  |
|---------------------|--|
| Installation:       | Three-wall alcove                                |
| Drain location:     | Center   |
| Weight:             | 33 lbs (15 kg)                                   |
| Minimum floor load: | 20 lbs/ft <sup>2</sup> (97.6 kg/m <sup>2</sup> ) |

## Notes

- Measure your actual product for rough-in details.
- Install this product according to the installation instructions.
- Shimming may be required to level the fixture.
- Shimming may be required between the stud frame and the fixture.
- Stud opening tolerance is + 1/4" (6 mm), - 0" (0 mm).