

### Features

- 36-inch minimum base cabinet width.
- Large single bowl.
- 9-inch depth.
- Single compartment.
- Three oversized faucet holes with two oversized accessory holes to the right.
- Strainer not included.

### Material

- KOHLER® enameled cast iron.
- Acid-resistant enamel finish.

### Installation

- Under-mount.
- Oversized holes allow for easy installation of faucets and accessories.

### Recommended Products/Accessories

K-9000 P-Trap  
K-6063 Sink Rack  
K-6377 Sponge Caddy  
K-6378 Kitchen Brush Caddy  
K-6379 Kitchen Squeegee  
K-6382 Disinfecting Wipes Dispenser  
K-6383 Soap Dispenser  
K-8618 Paper Towel Holder  
K-8619 Flexible Kitchen Mat  
K-8624 Dish Scraper  
K-8801 Sink Strainer  
K-8799 Sink Strainer  
K-6637 Cutting Board

### Optional Products/Accessories

1054375 Under-mount Sink Kit, 23"



### Codes/Standards

















ASME A112.19.1/CSA B45.2

### KOHLER® Enameled Cast Iron Kitchen Sink Lifetime Limited Warranty

See website for detailed warranty information.

### Available Colors/Finishes

*Color tiles intended for reference only.*

Color	Code	Description
	0	White
	FF	Sea Salt™
	96	Biscuit
	47	Almond
	FD	Cane Sugar™
	NY	Dune
	95	Ice™ Grey
	G9	Sandbar
	33	Mexican Sand™
	K4	Cashmere
	FT	Basalt
	58	Thunder™ Grey
	R1	Roussillon™ Red
	20	Suede
	KA	Black 'n Tan
	FP	Caviar
	7	Black Black™

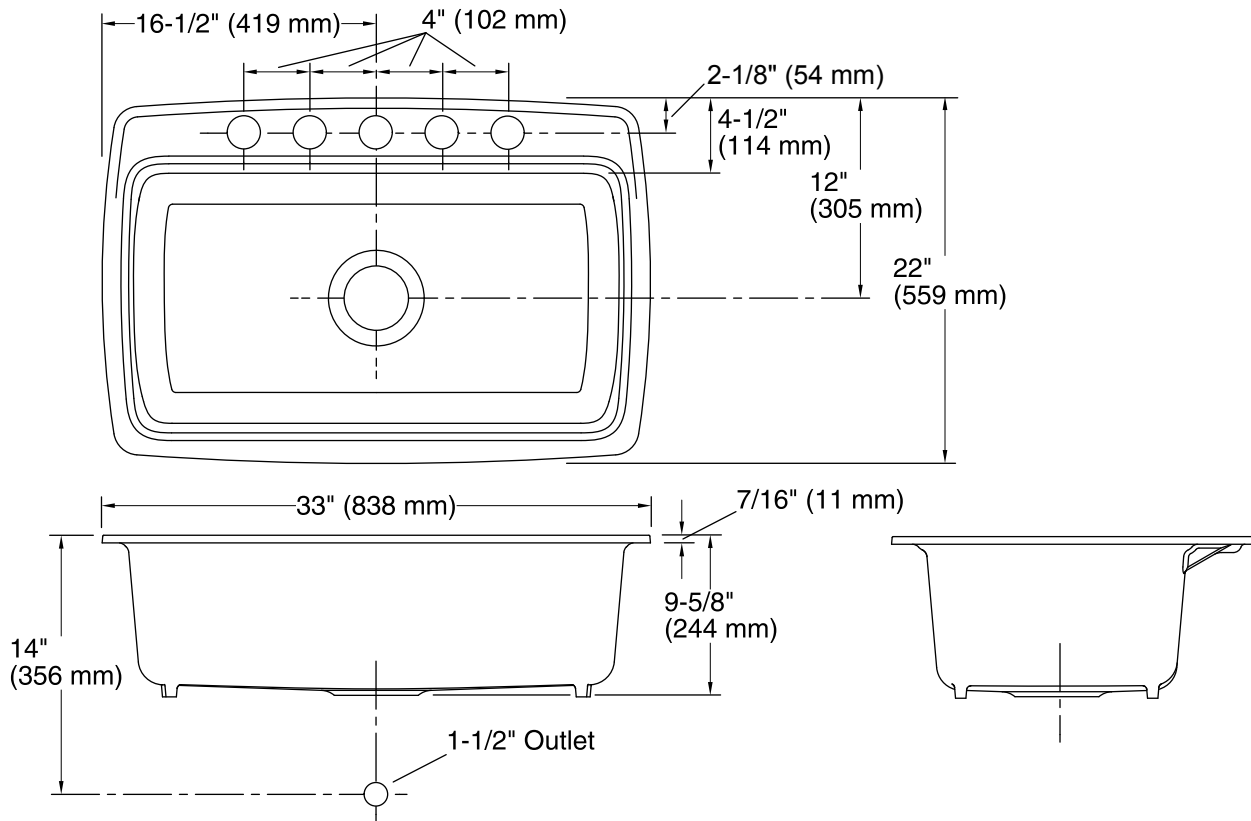

## Technical Information

All product dimensions are nominal.

Bowl configuration:	Single
Installation:	Under-mount
Min. base cabinet width:	36" (914 mm)
Bowl area (Only):	Length: 29" (737 mm) Width: 15" (381 mm) Bowl depth: 9" (229 mm)
Number of deck holes:	5
Faucet hole(s):	2-3/8" (60 mm)
Drain hole:	3-5/8" (92 mm)
Template:	Under-mount, 1034873-7, required, included

## Notes

Install this product according to the installation instructions.

Faucet holes in under-mount fixture are oversized at  $\tilde{A}$  2-3/8" (60 mm). Drill faucet holes in counter according to fitting roughing-in.