

### Features

- Molded lumbar support and armrests offer extra comfort while bathing.
- Integral apron.
- Integral flange helps prevent water from seeping behind wall and simplifies alcove installation.
- Textured bottom surface
- Left-hand drain.
- Coordinates with other products in the Devonshire collection.

### Material

- Acrylic

### Installation

- Three-wall alcove.

### Additional Hydrotherapy Options

- Soaking Bath - K-1184-LA
- Soaking Bath + Bask heated surface - K-1184-LAW
- BubbleMassage air bath - K-1357-GLA
- BubbleMassage air bath + Bask heated surface - K-1357-GLAW
- VibrAcoustic - K-1357-VBLA
- VibrAcoustic + Bask heated surface - K-1357-VBLAW
- Whirlpool - K-1357-LA
- Whirlpool + Bask heated surface - K-1357-LAW
- Whirlpool + heater - K-1357-HL

### Recommended Products/Accessories

K-7161-AF Bath Drain  
K-7213 27" Cable Bath Drain  
K-7214 27" Cable Bath Drain  
K-7259 Clearflo Bath Drain  
K-37380 30" Rough-in Cable Bath Drain  
K-37383 30" Rough-in Cable Bath Drain  
K-702200-G54 Frameless Sliding Bath Door  
K-702200-G73 Frameless Sliding Bath Door  
K-702200-L Frameless Sliding Bath Door  
K-702205-L Frameless Sliding Bath Door  
K-706000-D3 Frameless Sliding Bath Door  
K-706000-L Frameless Sliding Bath Door  
K-706003-L Frameless Sliding Bath Door  
K-706004-D3 Frameless Sliding Bath Door  
K-706004-L Frameless Sliding Bath Door  
K-706007-L Frameless Sliding Bath Door



### Codes/Standards







CSA B45.5/IAPMO Z124

### KOHLER® Plastic Baths and Receptors Lifetime Limited Warranty

See website for detailed warranty information.

### Available Colors/Finishes

*Color tiles intended for reference only.*

Color	Code	Description
	0	White
	96	Biscuit
	47	Almond
	NY	Dune
	G9	Sandbar
	58	Thunder™ Grey

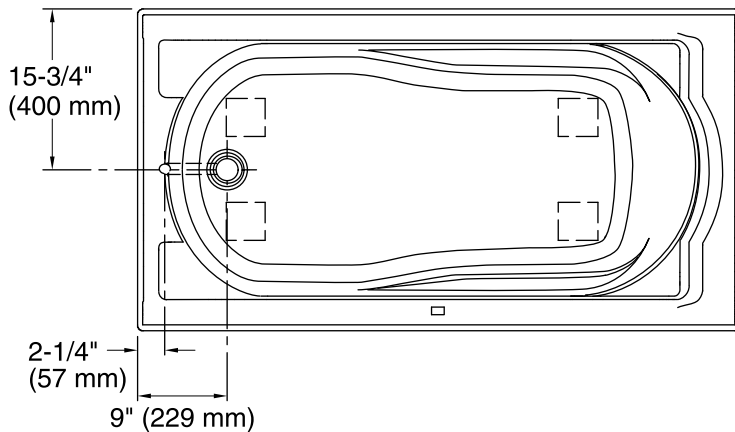

No change in measurements if connected with drain illustrated. (K-7161-AF)

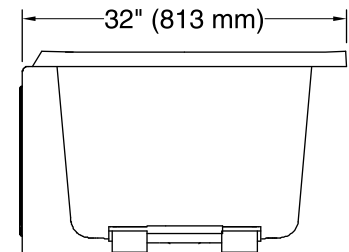
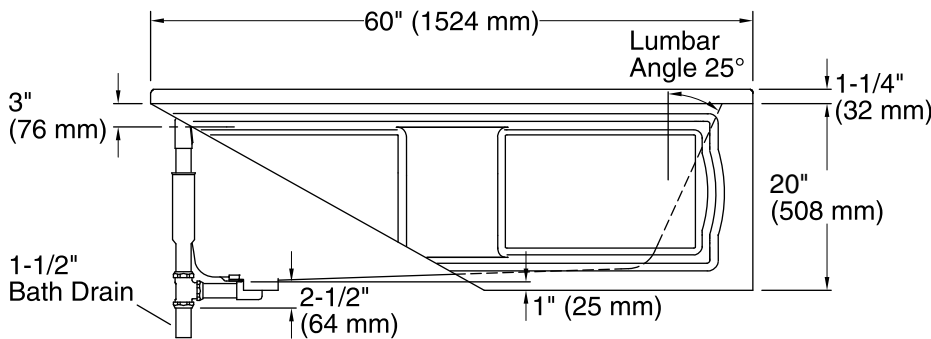
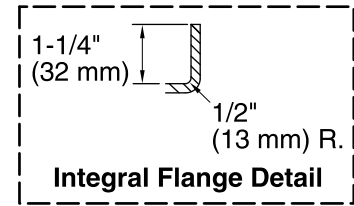

#### Technical Information

All product dimensions are nominal.

Installation:	Three-wall alcove
Drain location:	Left
Basin area, bottom:	42" x 20" (1067 mm x 508 mm)
Basin area, top:	51" x 24" (1295 mm x 610 mm)
Weight:	80 lbs (36.3 kg)
Minimum floor load:	41 lbs/ft <sup>2</sup> (200.2 kg/m <sup>2</sup> )
Water depth:	14" (356 mm)
Water capacity:	60 gal (227.1 L)
Minimum flat for door:	2-1/2" (64 mm)

#### Notes

Measure your actual product for rough-in details. Install this product according to the installation instructions. The hot water supply should be 70% of the capacity of the bath or greater. Installations will vary.