

KINGSTON

KITCHEN & BATH

Decorative Grade Grab Bar Installation

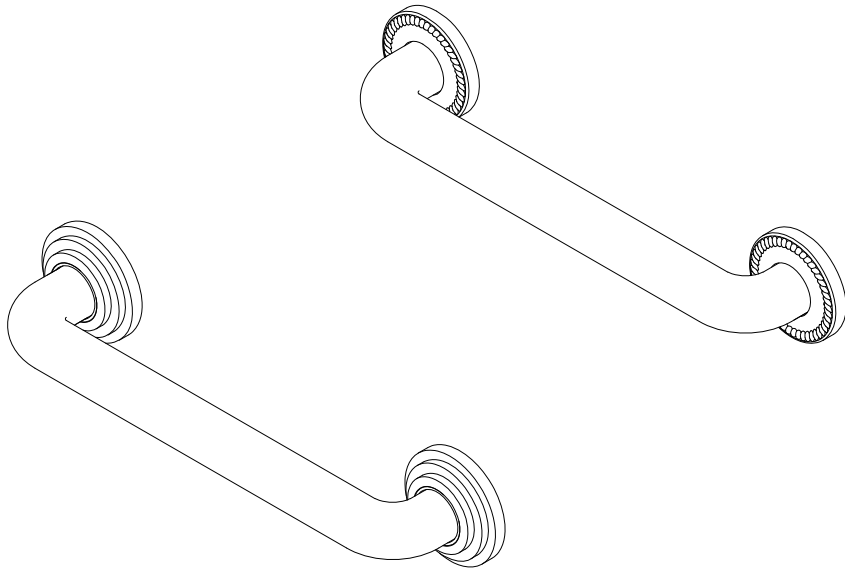

Parts:

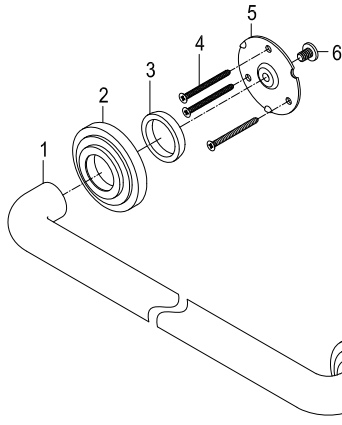

Parts Information:

- 1) Bar: 1 Pc
- 2) Decorative Flange: 2 Pcs
- 3) Friction Washer: 2 Pcs
- 4) Mounting Screw: 6 Pcs
- 5) Mounting Plate: 2 Pcs
- 6) Set Screw: 2 Pcs

www.kingstonbrass.com
TOLL-FREE CUSTOMER SERVICE: 1-877-2-KBRASS
TECHNICAL SUPPORT E-mail: service@kingstonbrass.com
12775 Reservoir Street, Chino, CA 91710

TOOLS REQUIRED



Marking Pencil



Allen Wrench

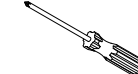

Phillips Screwdriver

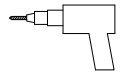

Power Drill

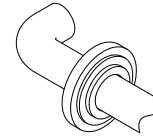

Fig. 1

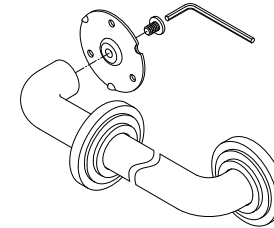

Fig. 2

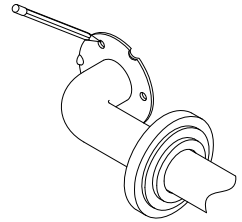

Fig. 3

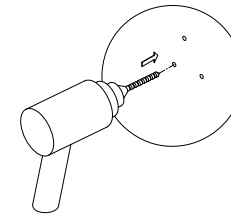

Fig. 4

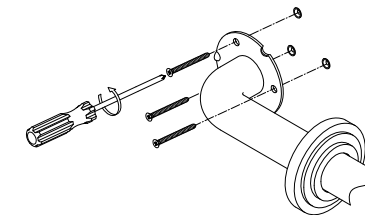

Fig. 5

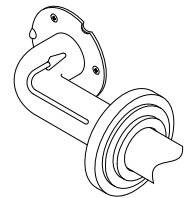

Fig. 6

Installation Steps:

1. Insert decorative flange. Make sure that underside is facing towards the end of the grab bar, insert cap onto end of grab bar.
2. Attach mounting plate and secure by threading Allen bolt (included).
3. Locate position on the wall and mark location of the holes.
4. Drill Starter holes (5/64").
5. Mount grab bar to the wall using 2" screws (Enclosed).

This grab bar is designed to be installed on wood bracing, if a proper wood bracing is not available consult your contractor as to the best anchors to use for your specific application some options available are Tile/ masonry anchors, toggle bolts, plastic anchors, metal anchors and drywall anchors.

Cleaning

Clean with a damp cloth only.
Avoid using metal or abrasive polishes.