

GRAB BARS SERIES

GRAB BAR WITH PAPER HOLDER

8289110L

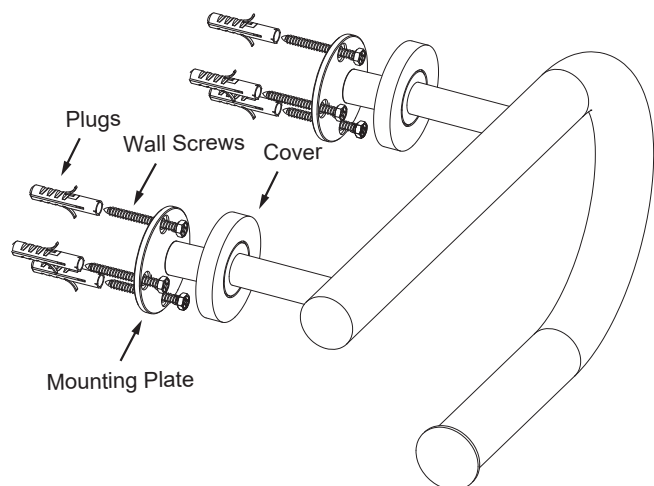

Tools required for installation

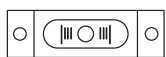

Level



Pencil



Wrench

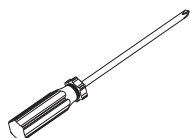

Screwdriver

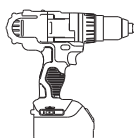

Drill



Hammer

A=Plate TOP holes center to center distance
 B=Plate TOP hole to BOTTOM hole distance
 C=Plate TOP/BOTTOM holes to MID hole distance

Product Code	Sizes (Inches/mm)		
	A	B	C
8289110	8 3/4"/220	1 3/4"/45	1"/22.5
8289110L	8 3/4"/220	1 3/4"/45	1"/22.5

Fig.1

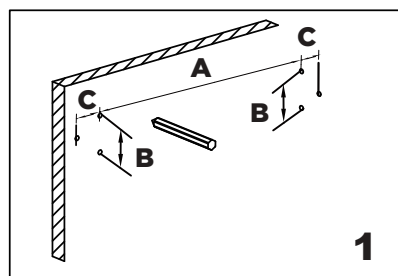

Mark (on the wall) locations of plugs through mounting plate using a pencil, refer to Fig.1

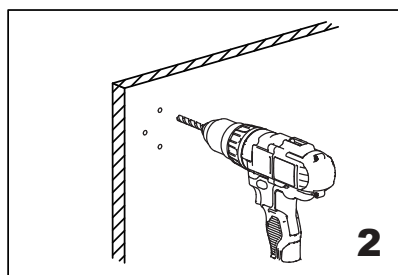

Drill 3/16" holes, make sure to keep drill level

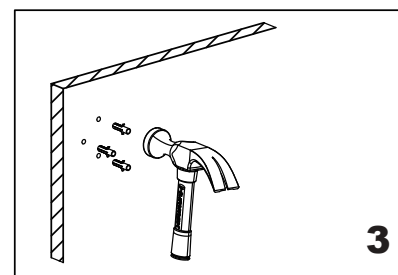

Insert plugs into drilled holes, using a hammer to tap the plugs in, be careful not to break tile

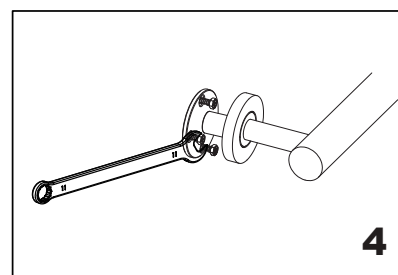

Driver bolt nut directly into holes

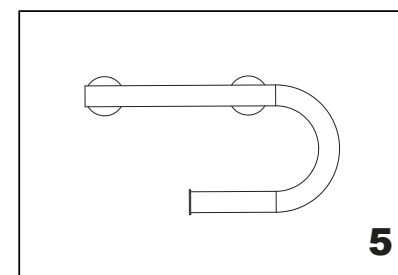

Tighten the cover on the Mounting plate