

BATHROOM
Camden Floor-Mounted Tub Filler
G-6954-LM48N

GRAFF[®]



Information

- Floor-mount installation
- Aerated spout flow rate ~8 gpm @45 psi
- Handshower flow rate ≤ 1.5 max gpm
- 8-13/16" spout reach
- 40-11/16" approximate height
- Includes handshower with 59" spiral flexible hose
- Optional in-line pressure balancing valve G-1060

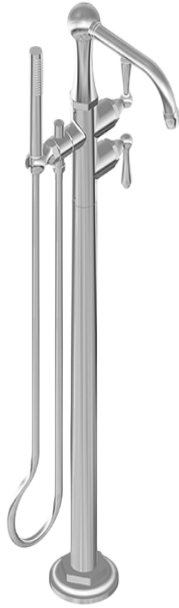

Product Features

- Floor-mount installation
- Aerated spout flow rate ~8 gpm @ 45 psi
- Handshower flow rate ≤ 1.5 max gpm
- 8-13/16" spout reach
- 40-11/16" approximate height
- Includes handshower with 59" spiral flexible hose

Optional Accessories

- Optional in-line pressure balancing valve G-1060

Available Finishes

- Polished Chrome
G-6954-LM48N-PC
- Brushed Nickel
G-6954-LM48N-BNi
- Polished Nickel
G-6954-LM48N-PN
- Olive Bronze
G-6954-LM48N-OB
- Unfinished Brass*
G-6954-LM48N-UB*
- Gold*
G-6954-LM48N-AU*
- Brushed Gold*
G-6954-LM48N-BAU*

* Special order finish - call for availability

Warranty

- Limited lifetime warranty

For complete warranty information go to <https://www.graff-faucets.com/en/info/faqs>

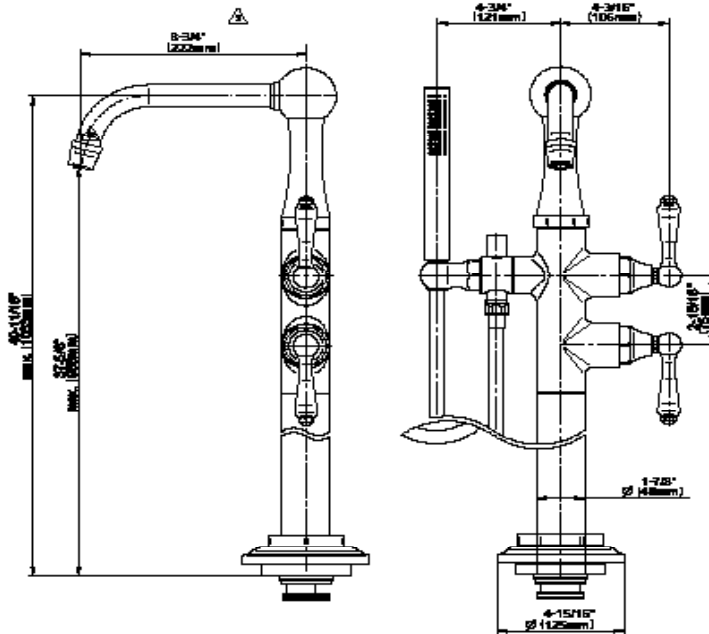















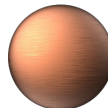

BATHROOM
Spout Connection Rough
G-1045

GRAFF®

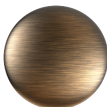
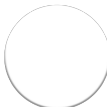

Finishes

							
24K Gold	24K Brushed Gold	Brushed Brass PVD	Architectural Black™	Brushed Nickel	Brushed Onyx PVD®	Brushed OR'osa PVD®	Gunmetal
							
Matte Black	Olive Bronze	Onyx PVD®	Polished Brass PVD	Polished Chrome	Polished Nickel	OR'osa PVD®	Unfinished Brass
							
Unfinished Brushed Brass	Vintage Brushed Brass	Architectural White					

G-1045

Spout Connection Rough



Product Features

- Mud guard displays minimum and maximum floor depth
- Rough can be installed in any orientation making it convenient to route pipes to the rough
- Trim can be rotated 360 degrees in any directions
- Averages 10 GPM with most trim

Warranty

- Limited lifetime warranty

For complete warranty information go to <http://www.graff-faucets.com/en/info/faqs>

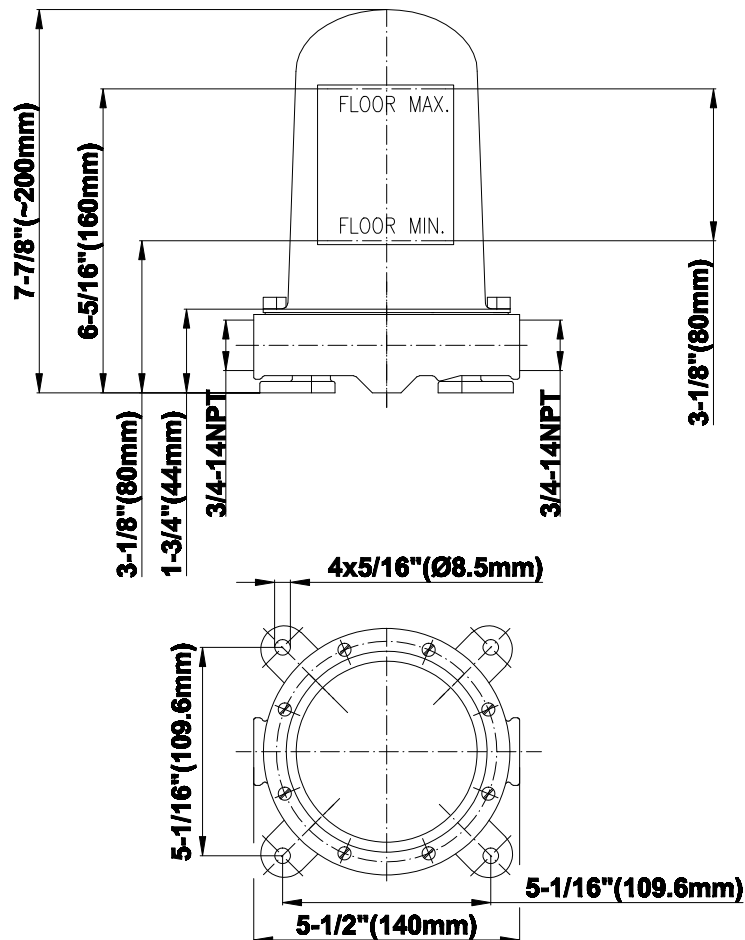

The measurements shown are for reference only. Products and specifications shown are subject to change without notice. Revised 07/2017.

www.graff-faucets.com | phone: 800-954-4723

BATHROOM
Camden Floor-Mounted Tub Filler
G-6954-LM48N

GRAFF®



Information

- Floor-mount installation
- Aerated spout flow rate ~8 gpm @45 psi
- Handshower flow rate ≤ 1.5 max gpm
- 8-13/16" spout reach
- 40-11/16" approximate height
- Includes handshower with 59" spiral flexible hose
- Optional in-line pressure balancing valve G-1060

Finishes

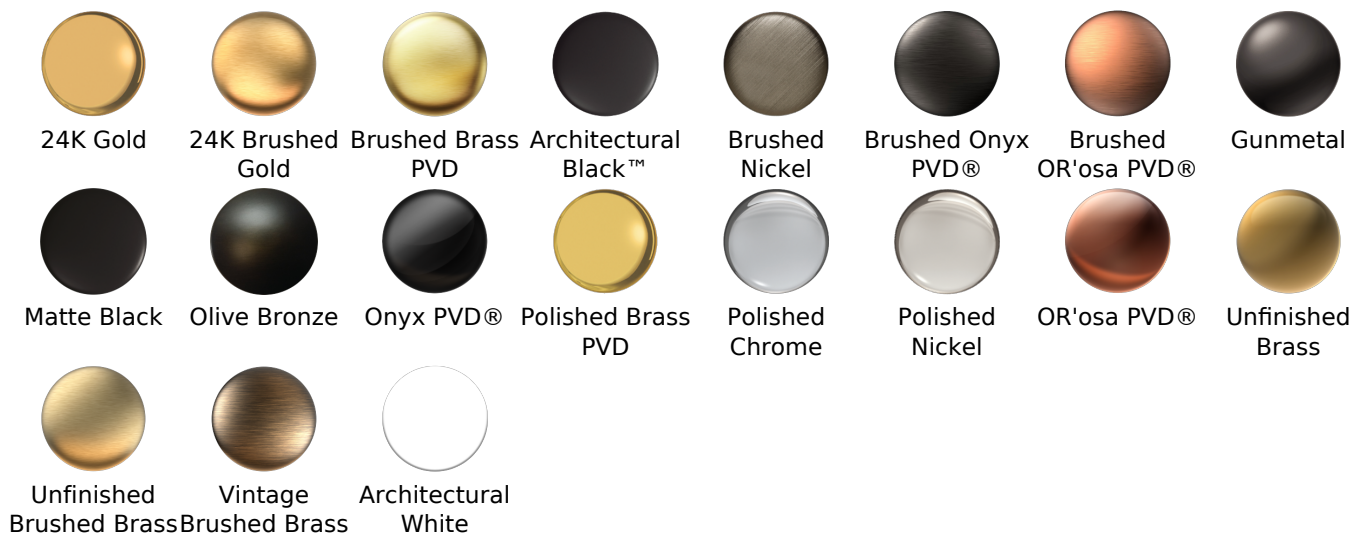

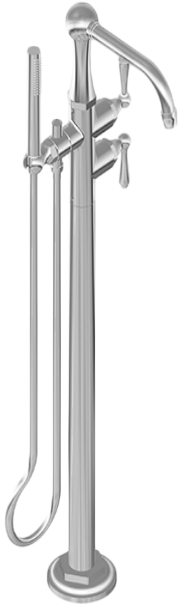

Product Features

- Floor-mount installation
- Aerated spout flow rate ~8 gpm @ 45 psi
- Handshower flow rate ≤ 1.5 max gpm
- 8-13/16" spout reach
- 40-11/16" approximate height
- Includes handshower with 59" spiral flexible hose

Optional Accessories

- Optional in-line pressure balancing valve G-1060

Available Finishes

- Polished Chrome
G-6954-LM48N-PC
- Brushed Nickel
G-6954-LM48N-BNi
- Polished Nickel
G-6954-LM48N-PN
- Olive Bronze
G-6954-LM48N-OB
- Unfinished Brass*
G-6954-LM48N-UB*
- Gold*
G-6954-LM48N-AU*
- Brushed Gold*
G-6954-LM48N-BAU*

* Special order finish - call for availability

Warranty

- Limited lifetime warranty

For complete warranty information go to <https://www.graff-faucets.com/en/info/faqs>

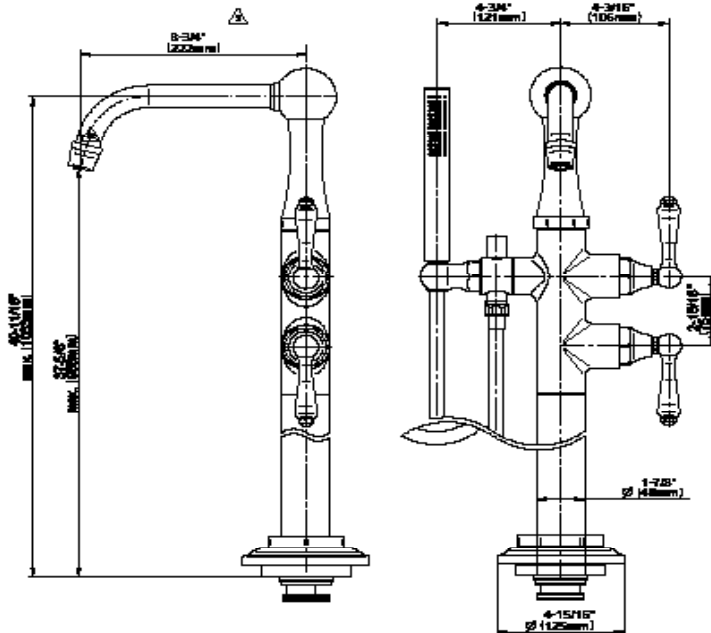

The measurements shown are for reference only. Products and specifications shown are subject to change without notice. Revised 5/2018.

www.graff-designs.com | phone: 800-954-4723