

PRODUCT SPECIFICATIONS

Elkay Lustertone™ Classic Stainless Steel 25" x 21-1/4" x 5", Single Bowl Drop-in ADA Sink. Sink is manufactured from 18 gauge 304 Stainless Steel with a Lustrous Satin finish, Rear Center drain placement, and Bottom only pads.

Installation Type:	Drop-in
Material:	304 Stainless Steel
Special Features:	Quick-Clip Mounting System
Finish:	Lustrous Satin
Gauge:	18
Sound Deadening:	Bottom only pads
Number of Bowls:	1
Sink Dimensions:	25" x 21-1/4" x 5"
Bowl 1 Dimensions:	21" x 15-3/4" x 4-7/8"
Drain Size:	3-1/2" (89mm)
Drain Location:	Rear Center
Minimum Cabinet Size:	30"
Mounting Hardware:	Included for 3/4" (19mm) countertop
Cutout Template #:	100001245

Template is available for download at [elkay.com](#)

Cutout Dimensions for Top Mount Installation:

24-3/8" x 20-5/8" (619mm x 524mm) with 1-1/2" (38mm) corner radius

Hole Drilling Configurations:

1-1/2" (38mm) Diameter Faucet Holes on 4" (102mm) Centers

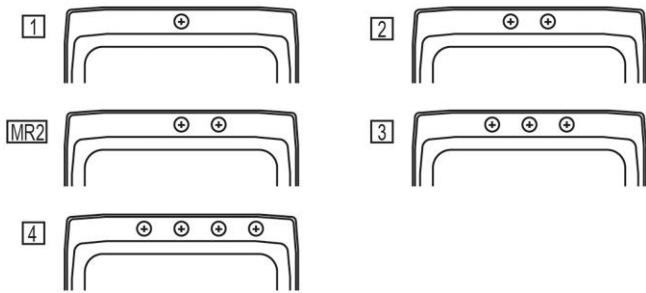

Installation Profile:

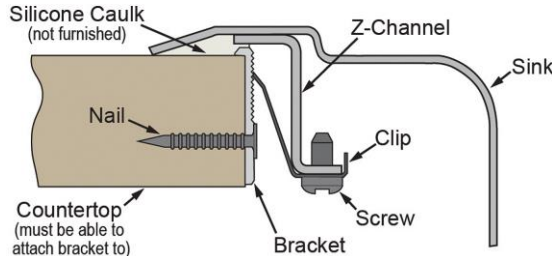

AMERICAN PRIDE. A LIFETIME TRADITION.

Like your family, the Elkay family has values and traditions that endure. For almost a century, Elkay has been a family-owned and operated company, providing thousands of jobs that support our families and communities.



Product Compliance: ADA & ICC A117.1
ASME A112.19.3/CSA B45.4
BUY AMERICAN ACT



Sinks are listed by IAPMO® as meeting the applicable requirements of the Uniform Plumbing Code®, International Plumbing Code®, and National Plumbing Code of Canada.



Complies with ADA & ICC A117.1 accessibility requirements when installed according to the requirements outlined in these standards.

- [Clean and Care Manual \(PDF\)](#)
- [Installation Instructions \(PDF\)](#)
- [Limited Lifetime Warranty \(PDF\)](#)

Similar models are available with: additional ADA depths, U Channel mounting system

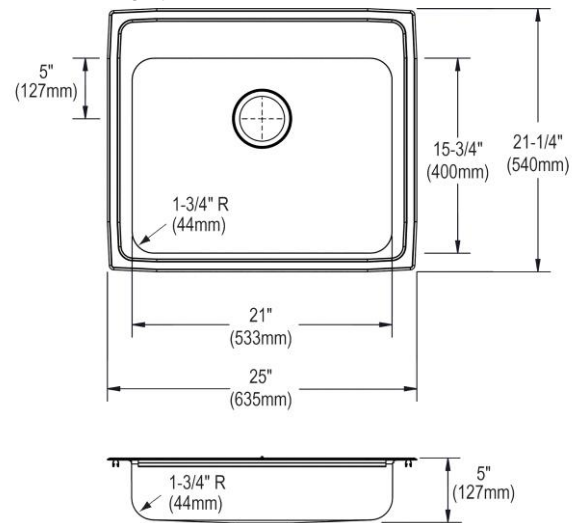

PART: _____ QTY: _____

PROJECT: _____

CONTACT: _____

DATE: _____

NOTES: _____

APPROVAL: _____

In keeping with our policy of continuing product improvement, Elkay reserves the right to change product specifications without notice. Please visit [elkay.com](#) for the most current version of Elkay product specification sheets. This specification describes an Elkay product with design, quality, and functional benefits to the user. When making a comparison of other producers' offerings, be certain these features are not overlooked.

OPTIONAL ACCESSORIES

Bottom Grid:	LKWOBG2115SS
Cutting Board:	CB1516
Drain:	LK99, LKAD35
Faucet:	LKGT1041, LKGT2041
Rinsing Basket:	LKWERBSS
Soap Dispenser:	LKGT1054

In keeping with our policy of continuing product improvement, Elkay reserves the right to change product specifications without notice. Please visit elkay.com for the most current version of Elkay product specification sheets. This specification describes an Elkay product with design, quality, and functional benefits to the user. When making a comparison of other producers' offerings, be certain these features are not overlooked.